

MIH user's guide

www.renishaw.com

MIH user's guide

Document part number H-1000-5200-09-F



MIH user's guide

www.renishaw.com

General information

© 2001 - 2022 Renishaw plc. All rights reserved.

 ORIGINAL LANGUAGE VERSION

This document may not be copied or reproduced in whole or in part, or transferred to any other media or language by any means, without the prior written permission of Renishaw.

Disclaimer

WHILE CONSIDERABLE EFFORT WAS MADE TO VERIFY THE ACCURACY OF THIS DOCUMENT AT PUBLICATION, ALL WARRANTIES, CONDITIONS, REPRESENTATIONS AND LIABILITY, HOWSOEVER ARISING, ARE EXCLUDED TO THE EXTENT PERMITTED BY LAW.

RENISHAW RESERVES THE RIGHT TO MAKE CHANGES TO THIS DOCUMENT AND TO THE EQUIPMENT, AND/OR SOFTWARE AND THE SPECIFICATION DESCRIBED HEREIN WITHOUT OBLIGATION TO PROVIDE NOTICE OF SUCH CHANGES.

Trade marks

RENISHAW[®], the probe symbol and REVO[®] are registered trade marks of Renishaw plc.

Renishaw product names, designations and the mark 'apply innovation' are trade marks of Renishaw plc or its subsidiaries.

Other brand, product or company names are trade marks of their respective owners.

WEEE



The use of this symbol on Renishaw products and / or accompanying documentation indicates that the product should not be mixed with general household waste upon disposal. It is the responsibility of the end user to dispose of this product at a designated collection point for waste electrical and electronic equipment (WEEE) to enable reuse or recycling. Correct disposal of this product will help to save valuable resources and prevent potential negative effects on the environment. For more information, please contact your local waste disposal service or Renishaw distributor.

Warranty

Unless you and Renishaw have agreed and signed a separate written agreement, the equipment and/or software are sold subject to the Renishaw Standard Terms and Conditions supplied with such equipment and/or software, or available on request from your local Renishaw office.

Renishaw warrants its equipment and software for a limited period (as set out in the Standard Terms and Conditions), provided that they are installed and used exactly as defined in associated Renishaw documentation. You should consult these Standard Terms and Conditions to find out the full details of your warranty.

Equipment and/or software purchased by you from a third-party supplier is subject to separate terms and conditions supplied with such equipment and/or software. You should contact your third-party supplier for details.

MIH user's guide

www.renishaw.com

Care of equipment

Renishaw probes and associated systems are precision tools used for obtaining precise measurements and must therefore be treated with care.

Changes to Renishaw products

Renishaw reserves the right to improve, change or modify its hardware or software without incurring any obligations to make changes to Renishaw equipment previously sold.

Company registration details

Renishaw plc. Registered in England and Wales. Company no: 1106260. Registered office: New Mills, Wotton-under-Edge, Gloucestershire, GL12 8JR, UK.

Packaging

To aid end user recycling and disposal the materials used in the different components of the packaging are stated here:

Packaging component	Material	94/62/EC code	94/62/EC number
Outer box	Corrugated fibreboard	PAP	20
Packaging insert	Corrugated fibreboard	PAP	20
Bag	Low density Polyethylene	LDPE	04

MIH user's guide

www.renishaw.com

Product compliance

EU declaration of conformity

Contact Renishaw plc or visit www.renishaw.com/EUCMM for the full EU declaration.

UK declaration of conformity

Contact Renishaw plc or visit www.renishaw.com/UKCMM for the full UK declaration.

EMC conformity

This equipment must be installed and used in accordance with this installation guide. This product is intended for industrial use only and should not be used in a residential area or connected to a low voltage power supply network which supplies buildings used for residential purposes.

FCC (USA only)

Information to user (47 CFR 15.105)

This equipment has been tested and found to comply with the limits for a Class A digital device, pursuant to Part 15 of the FCC rules. These limits are designed to provide reasonable protection against harmful interference when the equipment is operated in a commercial environment. This equipment generates, uses, and can radiate radio frequency energy and, if not installed and used in accordance with the instruction manual, may cause harmful interference to radio communications. Operation of this equipment in a residential area is likely to cause harmful interference, in which case you will be required to correct the interference at your own expense.

Information to user (47 CFR 15.21)

The user is cautioned that any changes or modifications not expressly approved by Renishaw plc or authorised representative could void the user's authority to operate the equipment.

Equipment label (47 CFR 15.19)

This device complies with part 15 of the FCC Rules. Operation is subject to the following two conditions:

1. This device may not cause harmful interference.
 2. This device must accept any interference received, including interference that may cause undesired operation.
-

MIH user's guide

www.renishaw.com

ICES-001 (Canada only)

This ISM device complies with Canadian ICES-001(A) / NMB-001(A).

Cet appareil ISM est conforme à la norme ICES-001(A) / NMB-001(A) du Canada.

REACH regulation

Information required by Article 33(1) of Regulation (EC) No. 1907/2006 ("REACH") relating to products containing substances of very high concern (SVHCs) is available at:

www.renishaw.com/REACH

China RoHS

Contact Renishaw plc or visit www.renishaw.com/ChinaRoHSCMM for the full China RoHS tabulation.



MIH user's guide

www.renishaw.com

Introduction

Renishaw's MIH is a compact manual indexable probe head which offers the flexibility and time saving normally associated with direct computer controlled (DCC) machines and motorised probe heads.

The MIH is adjustable in two axes, both of which can be unlocked by a single thumbwheel operation. A probe / stylus combination can be orientated to 720 different positions and, once the head is locked, each position will be repeatable to 1 μm^* (0.00004 in) (2σ). Hence the user can return to any chosen position without having to requalify the probe / stylus tip.

The current position is shown on the integral liquid crystal display (LCD) and is constantly updated during moves.

The programmable memory facility allows pre-datumed positions to be stored in a memory within the head. Direction arrows shown on the LCD take the user back to any one of 20 memorised positions which can be arranged in any order to suit a particular inspection sequence. The sequence can be edited as required.

Probes are attached to the MIH by means of the Renishaw autojoint, allowing the user to easily exchange probes whilst maintaining repeatability to 0.5 μm^* (0.00002 in) (2σ). The autojoint is recessed into the head, thus maximising the valuable working volume of the machine.

* Measured at 67 mm (2.64 in) from autojoint (TP6A probe with 21 mm (0.83 in) stylus)

Features

- Manually indexable in 2 axes
- Positionally repeatable to 1 μm^* (0.00004 in) (2σ)
- 720 selectable positions
- LCD display
- Programmable memory function
- Simple operation
- Compact size
- Renishaw autojoint probe mounting
- No special installation required

* Measured at 67 mm (2.64 in) from autojoint (TP6A probe with 21 mm (0.83 in) stylus)

Recommendations

- DO** mount the head as rigidly as possible in the CMM quill.
- DO** ensure that the head is properly locked before attempting to use the probe to take points.
- DO** support probe / extension set-ups of longer than 150 mm by hand when locking or unlocking the head.
- DO** disarm the probe during moves if possible. This can be achieved via the application software and will avoid false triggers.
- DO** change the battery when low battery indicator is ON.
- DO** reposition the head by moving only one axis at a time to ensure best practise.
- DO** unlock and relock the head after a probe change.
- DO NOT** rotate the head axes by holding the probe stylus.
- DO NOT** move the CMM by holding the head.
- DO NOT** attempt to use a probe whilst the head is unlocked.
- DO NOT** leave the head unlocked for long periods.
- DO NOT** use probe extensions over 300 mm long.
- DO NOT** lock the head in an overtravel position.
- DO NOT** move the axes beyond overtravel positions.

MIH user's guide

www.renishaw.com

Major components

MIH - front

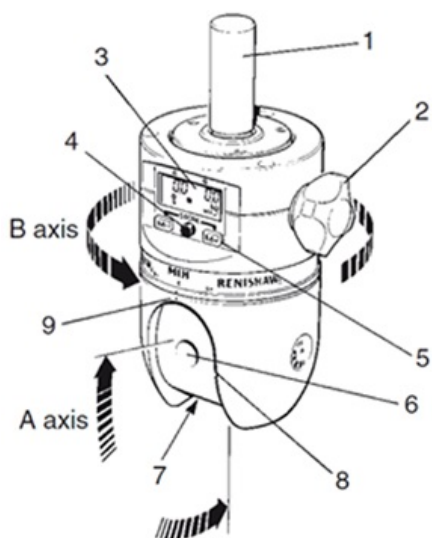

Key	Description
1	Mounting shank
2	Lock / unlock thumbwheel
3	LCD display
4	Probe status LED
5	LCD memory programming buttons
6	Probe autojoint lock / unlock access window
7	Renishaw autojoint probe mounting (recessed into A-axis swivel)
8	A-axis zero position markers
9	B-axis zero position markers

MIH user's guide

www.renishaw.com

MIH - back

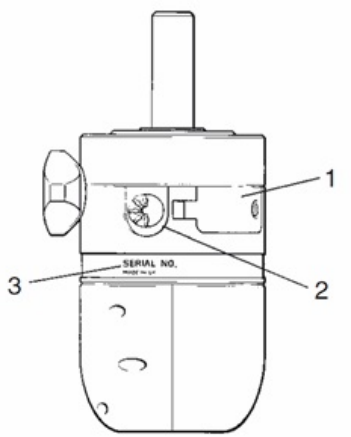

Key	Description
1	Battery housing
2	5-pin DIN connector
3	Serial number

MIH user's guide

www.renishaw.com

LCD display

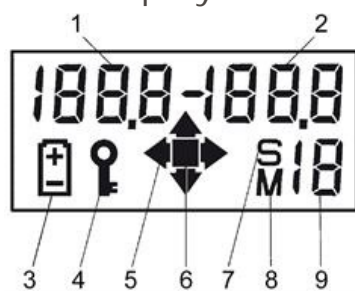

Key	Description
1	A-axis positional data (0 to +105)
2	B-axis positional data (-180 to +180)
3	Low battery indicator
4	Head locked symbol
5	Rotation direction arrows
6	Position confirmation symbol
7	Sequence store indicator
8	Memory mode indicator
9	Memory number

Installation

Fitting the battery

1. Move MIH to axis positions A0.0, B0.0 and lock up.
2. Unscrew housing retaining screw.
3. Open housing door.
4. Insert battery as shown (negative end first).
5. Close door and secure retaining screw (do not overtighten).
6. Reset datum (See 'Datum mode').

i **NOTE:** Incorrect insertion of the battery will not cause damage to the MIH.

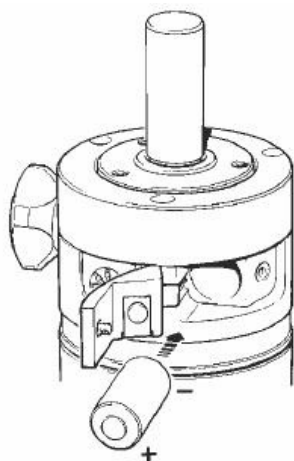

MIH user's guide

www.renishaw.com

Fitting the probe

1. Offer up the female autojoint with key slot facing as shown.
2. Using an S10 autojoint key, insert into access hole and locate blade in key slot.
3. Rotate clockwise to lock the autojoint.
4. Once qualified, probe / stylus combinations may be interchanged without the need to re-qualify.
5. After changing a probe, unlock and re-lock the head to ensure repeatability.

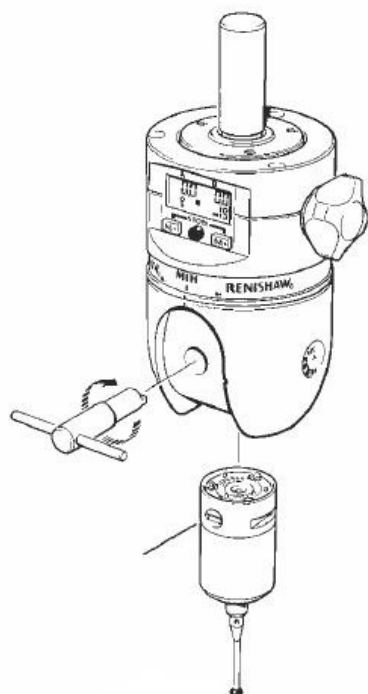

Pin connections

1. Insert Renishaw 5-pin DIN plug into socket.
2. Head LED cathode
3. Ground
4. Head LED anode
5. Probe circuit
6. Probe circuit

MIH user's guide

www.renishaw.com

Quill mounting

Ensure that the head is securely mounted onto the CMM quill. Any rotational movement occurring during use will result in a loss of repeatability of positional data.

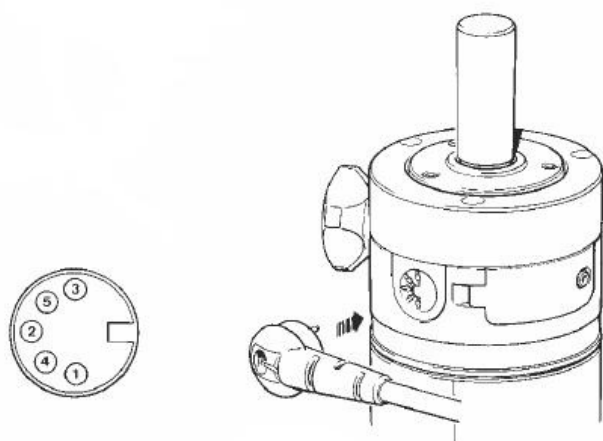

CAUTION: Always fit mounting shanks with the screws supplied (M3 × 5 mm (0.20 in) long). The use of incorrect screws may cause serious internal damage to the head.

MIH user's guide

www.renishaw.com

Using the MIH

Unlocking the head

Both A and B-axes are unlocked by a single turn of the thumbwheel in a counter-clockwise direction. The locked (key) symbol on the LCD will disappear. Probes / extensions longer than 150 mm should be supported by hand when locking or unlocking the head.

Locking the head

To lock the head correctly after positioning, support the probe (and extension, if fitted) and turn the thumbwheel clockwise until a positive 'click' is felt. A correct 'lock-up' is confirmed by the appearance of the key symbol on the LCD. To ensure repeatability, it is important to simply support the probe / extension during lock-up and NOT to constrain it.

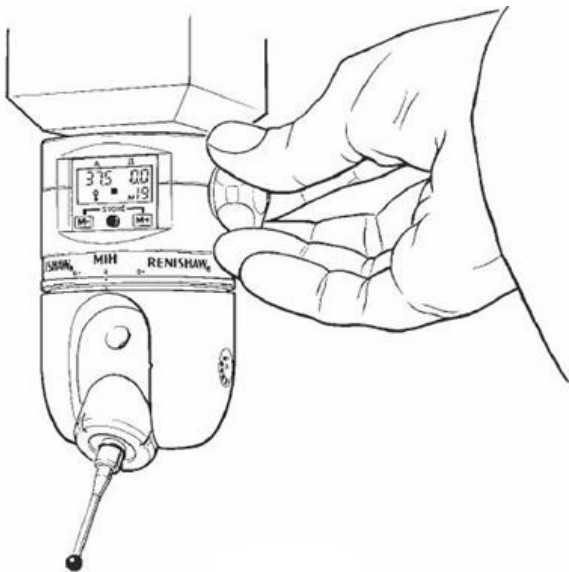

NOTE: Do not leave the head unused in an unlocked position as this will shorten battery life.

MIH user's guide

www.renishaw.com

Positioning the head

Rotation of each axis is achieved against a built-in kinematic mechanism. This provides the user with discreet 7.5° incremental positions so that the head cannot be locked in a non-repeatable position.

The B-axis is positioned by holding the lower housing and rotating until the required position is reached.

The A-axis is positioned by holding the probe or extension body as close to the head as possible and rotating until the required position is reached.

To ensure maximum repeatability, each axis should be moved separately, and should not be moved beyond overtravel positions.

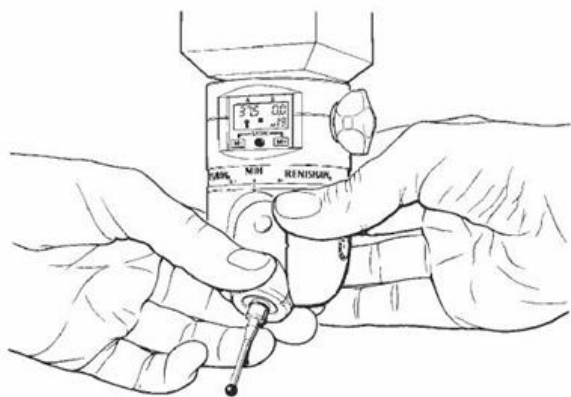

CAUTION: Do not change axis positions by holding the stylus, as this will cause damage to the probe.

MIH user's guide

www.renishaw.com

MIH LCD / software facility

A and B-axis positional data is shown on an integral liquid crystal display (LCD). When the head is unlocked and repositioned, position detectors fitted in each axis update the display which will show live position data. Power for the LCD / software is supplied by a battery fitted within the head which should be replaced when the low battery indicator is shown. Under normal use, the head will still function for many days after the low battery indicator appears.

The MIH also has a user-friendly software facility which is operated by two buttons. The software facility operates in four modes which are entered and exited by button presses and / or time-out periods of non-use. The locked symbol and low battery indicator function in all modes.

Datum mode

This mode has automatic entry when the battery is first fitted or replaced. Datum mode requires the user to set the A and B-axis position detectors to zero and must be completed successfully before the LCD can be used. Datum mode may also be automatically entered if an error occurs in the axis position detectors, caused by mis-use of the head. Again, correct datuming of the head must be completed before use can commence. See '[Datum mode](#)' for step-by-step instructions.

Simple mode

The software automatically enters simple mode upon completion of the datuming routine. Following the time-out of other modes, the MIH software will always return the user to simple mode. This is a use-only mode in which live A and B-axis data will always be shown.

In addition, if the head is locked in a position which corresponds to one which has been previously stored in memory, the memory number will be displayed on lock-up. See '[Simple mode](#)' for step-by-step instructions.

Memory mode

The user can enter memory mode from simple mode by pressing either the M+ or M- button. In this mode the MIH memory can be programmed or used. In memory mode, chosen head positions can be stored in up to 20 memory stores. Each position is allocated a memory number (0 to 19). In use, a chosen memory number is selected and direction arrows on the LCD lead the user to rotate the axis until the position stored in that memory is achieved. If the user fails to achieve the selected position, this condition is indicated by the flashing of the direction arrows on lock-up. Once the correct position is reached, the arrows disappear and the head position confirmation symbol is shown.

Exit from memory mode will occur after a 10 second period of inactivity and the head will revert to simple mode. A simple button press will return the user to memory mode. See '[Memory mode](#)' for step-by-step instructions.

Sequence mode

Sequence mode can be entered by a 5 second press of both M+ and M- buttons from simple mode.

In sequence mode, pre-memorised head positions can be arranged in any order to suit a particular sequence of inspection. Up to 20 sequence position numbers are available and the sequence can be edited as required. In use, the direction arrows lead the user through the pre-programmed sequence and will confirm that the head is locked in a correct position. The display automatically indicates the next position in the sequence when the head is next unlocked. See '[Sequence mode](#)' for step-by-step instructions.

MIH user's guide

www.renishaw.com

Conserving battery life

To conserve battery life, the LCD will automatically power down if the head is left in an unlocked state and remains unused for more than 20 seconds.

The LCD will return to its exact display before the 20 second time-out upon lock-up.

Rotating either axis whilst the LCD is in this powered-down state will return the user to datum mode upon lock-up (see '[Datum mode](#)').

This function will automatically operate if the head is left unlocked in any mode.

Stored memories and sequences remain unaffected by this function.

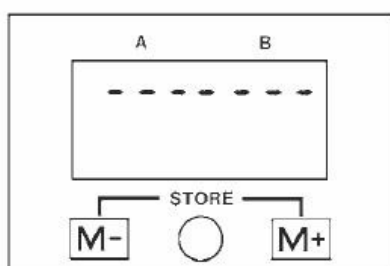

NOTE: Do not leave the head unused in an unlocked position, as this will shorten battery life.

MIH user's guide

www.renishaw.com

Datum mode

When the battery is first inserted or replaced, the MIH enters a datum mode routine which must be successfully completed prior to use. The A and B-axis position detectors within the head require datuming to a zero position before the LCD will display the correct A and B-axis positions. Datuming the head will also be required if a head datum error occurs during use.

Step 1

On entry into datum mode the LCD shows a datum error. Unlock the head to reset datum.

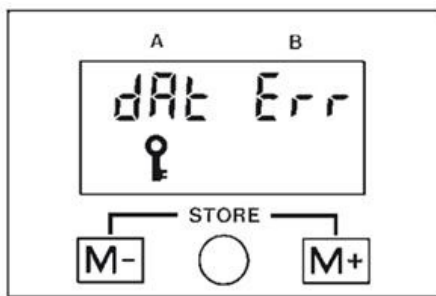

Step 2

Rotate the A and B-axes to their zero positions by aligning the zero position markers on both axes.

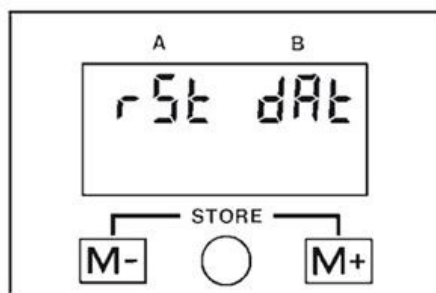

Step 3

Lock the head in this position and press the M+ and M- buttons simultaneously to reset datum.

MIH user's guide

www.renishaw.com

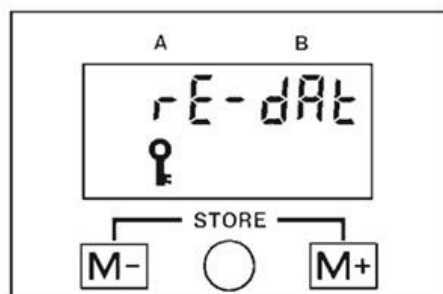

Step 4

The display will now change to show A and B-axis data at A0.0, B0.0. Datum is now set and the A and B-axis displays will show positional data when the head is locked and unlocked.

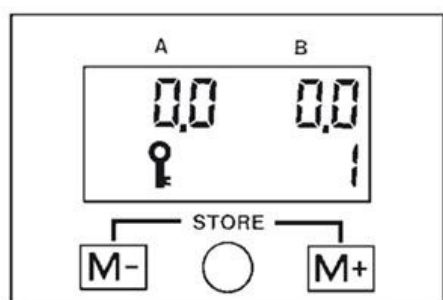

Step 5

Confirm that datum is correctly set by rotating each axis to its extreme positions and check that the position data on the LCD is correct.

A-axis 0° to +105° plus overtravel

B-axis ±180° plus overtravel.

MIH user's guide

www.renishaw.com

Simple mode

Following insertion of the battery and datuming of the head, the MIH is now ready to be used in simple mode. All data shown in the A and B-axis positions on the LCD will be 'live'.

Example: To use the MIH repeatably in positions A0.0, B0.0 and A105.0, B-180.0 (see steps 1 - 3 below).

Step 1

Position the head to A0.0, B0.0 and lock in position. Qualify the probe tip on your CMM in the normal manner. The stored tip number should be noted, together with the corresponding A and B-axis positions on the MIH.

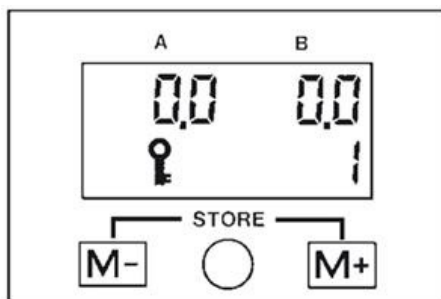

Step 2

Unlock the head and rotate the A and B-axes until the required position is reached - in this example.

A105.0, B -180.0

If overtravel in either axis occurs, the 'O-t' symbol will appear in the axis data on the LCD. Rotate the head to a valid position.

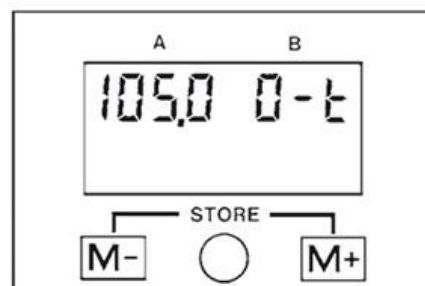
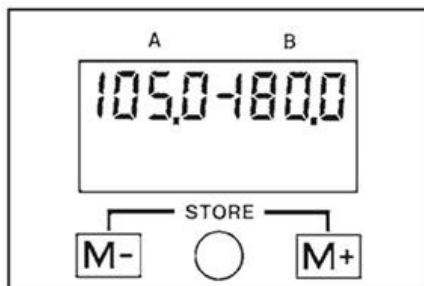

CAUTION: Do not attempt to lock the head in an overtravel position.

MIH user's guide

www.renishaw.com

Step 3

Lock the head in a valid position, A105.0, B-180.0. Qualify the probe tip on your CMM in the normal manner. The stored tip number should be noted, together with the corresponding A and B-axis positions on the MIH.

The MIH can now be used in either of the two pre-qualified positions (A0.0, B0.0 or A105.0, B-180.0) without the need to re-qualify the probe tip after each move. Simply unlock the head, move to the required position and lock up. The previously stored tip data for that head position can be recalled from the CMM computer software ready to take points.

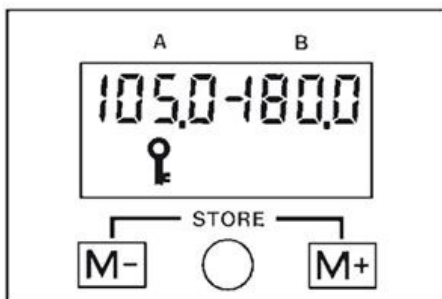

The head can be used in this way in up to 720 repeatable positions. The number of positions which are to be used will be dictated by the workpiece requiring inspection, but in some cases may be restricted by the number of storage positions for tip data available on your CMM software. Please consult your CMM supplier for further details.

Attempting to move the head axes whilst locked will cause damage and may result in movement of the axis position detectors in severe cases. Should this occur, the MIH software will signal an axis error message and will ask for a datum reset when unlocked. See step 2 of the '[Datum mode](#)' page for details of this routine.

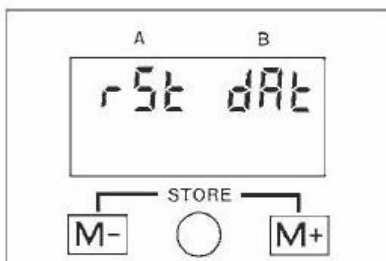

If the head is in a locked position which has previously been stored within the head's programmable memory function, the memory number corresponding to that position will show on the LCD screen upon lock-up. For further details on its use see the '[Memory mode](#)' page.

MIH user's guide

www.renishaw.com

Memory mode

When the battery is first fitted, all memory locations are pre-set to A0.0, B0.0. Pressing either the M+ or M- button when in simple mode activates memory mode.

Step 1

In this example the head is positioned and locked at A0.0, B0.0 in simple mode.

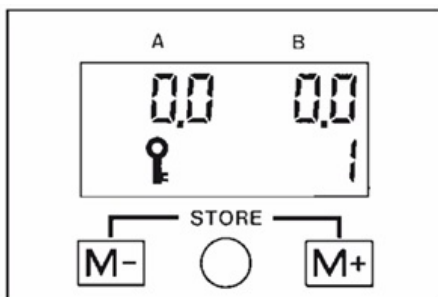

Step 2

The M+ or M- button is pressed to activate memory mode. Memory location 1 is shown on the LCD and the axis data stored in that location is shown in the A and B-axis position displays. Because the head is at this position (A0.0, B0.0), the direction arrows do not show, only the position confirmation block shows. If no button presses or head lock/unlock occur within 10 seconds, the LCD reverts to simple mode.

M1 now = A0.0, B 0.0

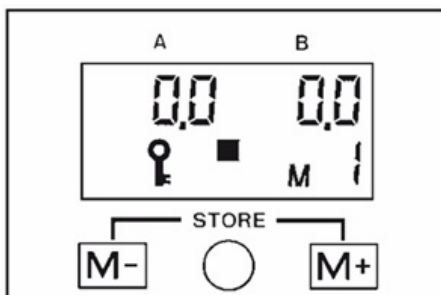

MIH user's guide

www.renishaw.com

Step 3

The head is unlocked, repositioned and locked at A30.0, B30.0 in simple mode.

Press M+ to activate memory mode.

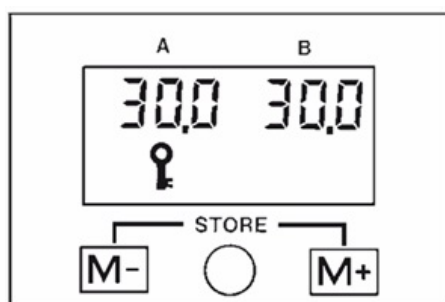

Step 4

Memory location M1 is displayed (A0.0, B0.0) since this was the last memory number used.

As the head is not in this position, the direction arrows appear showing the direction in which each axis must be rotated to achieve the position stored in M1 (A0.0, B0.0).

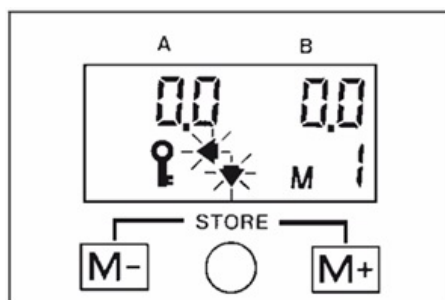

MIH user's guide

www.renishaw.com

Step 5

To store A30.0, B30.0 in memory location M2, press M+ and the memory number will increment until M2 is reached.

Currently A0.0, B0.0 is stored in M2 and this is displayed together with the flashing direction arrows showing how this position can be reached.

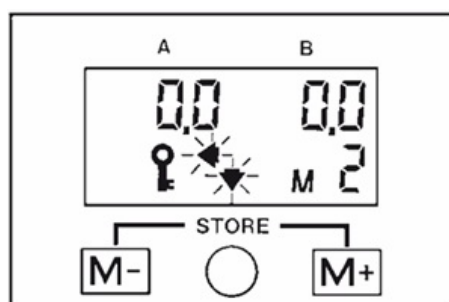

Step 6

Pressing the M+ and M- buttons simultaneously for longer than half a second will store A30.0, B30.0 in memory location 2.

The display will then 'blink' to show that the position data is stored in the memory.

This is confirmed by A30.0, B30.0 appearing in the A and B axis displays and the direction arrows disappearing, leaving only the confirmation block.

M2 now = A30.0, B30.0

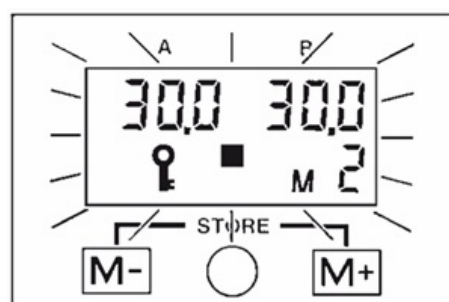

Step 7

To return the head to a previously memorised position M1 (A0.0, B0.0) press M- to decrement the memory number to M1. The direction arrows flash to show the direction moves required to reach that position and the axis data stored in M1 (A0.0, B0.0) is displayed.

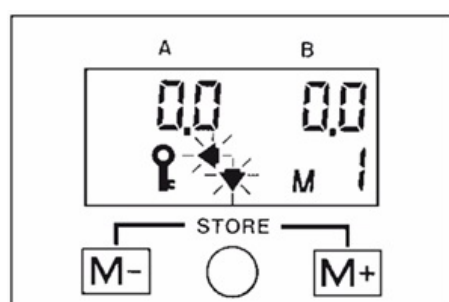

MIH user's guide

www.renishaw.com

Step 8

Unlock the head to display live positional data. The direction arrows remain but stop flashing.

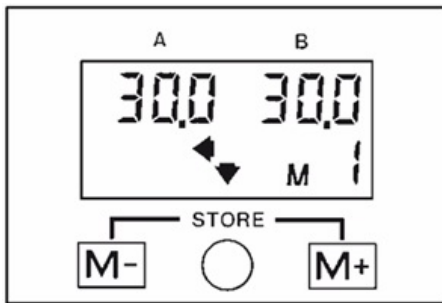

Step 9

Rotate the A and B-axes in the directions indicated by the arrows until both arrows disappear and the position confirmation block comes on. This confirms that the head is now in the position stored in the memory location indicated.

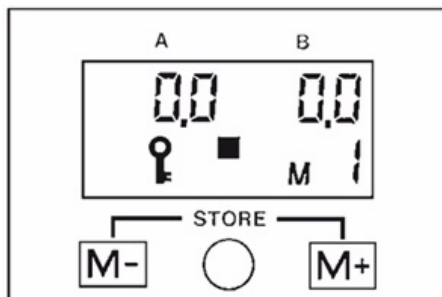

NOTE: If you overshoot the target position chosen in either axis, the direction arrows will lead you back to the required position. If the head is locked in an incorrect position, the direction arrows will flash. The arrows will stop flashing after 10 seconds and the display will return to simple mode showing 'live' position data. If either button is pressed, the screen will return to the last used memory display.

The memory numbers are incremented or decremented by pressing either the M+ or M- buttons respectively. Pressing either button and keeping it pressed will cause the memory numbers to scroll up or down at the rate of two per second.



MIH user's guide

www.renishaw.com

Sequence mode

When the battery is first inserted, sequence step 1 contains the contents of memory 1, sequence step 2 contains the contents of memory 2 and so on up to sequence step 19. Step 20 contains an end of sequence marker (E).

By pressing the M+ and M- buttons simultaneously (for 5 seconds) when the head is locked in simple mode, sequence mode is entered.

The display gives the choice to either use the existing sequence (press M- button) or edit the sequence to create a new one (press M+). If no choice is made within 5 seconds, the display will return to simple mode.

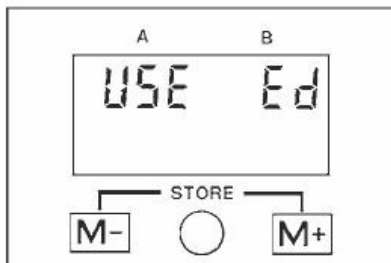

Step 1

Pressing the M+ button to edit, the sequence is entered at step 1. The existing contents of this step (in this case memory 1) are also displayed.

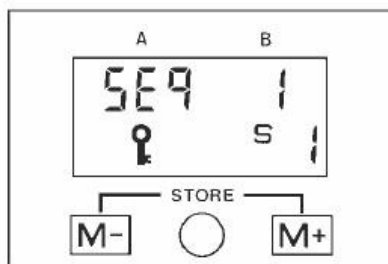

Step 2

Pressing M+ or M- will increment or decrement the sequence step numbers and the display will show the memory number stored in each sequence step. Keeping the M+ or M- buttons pressed will scroll through the sequence steps at the rate of two per second.

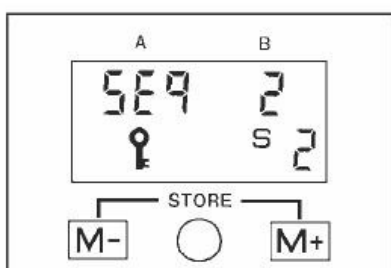

MIH user's guide

www.renishaw.com

Step 3

Once the sequence step to be changed is chosen (in this example step 3 currently containing memory number 3), pressing the M+ and M- buttons simultaneously for between half a second and 3 seconds* changes the display.

The S character disappears and the M character will be shown. This confirms that the sequence step chosen (step 3) is now frozen, and that the new contents can be chosen by pressing either the M+ or M- button to scroll up or down through the memory numbers.

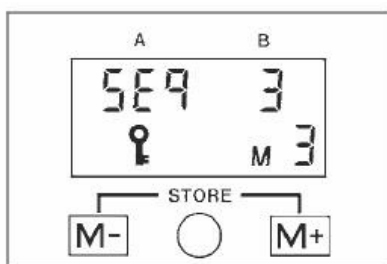

Step 4

Once the memory number to be stored in sequence step 3 has been chosen (in this example memory 5), pressing the M+ and M- buttons simultaneously for between half a second and 3 seconds* will store memory 5 in sequence step 3. This is confirmed by a store (Sto) message appearing on the display. The M character disappears and the S character reappears, confirming that the function of the M+ and M- buttons has been transferred back to selecting sequence steps.

* If the buttons are held for longer than 3 seconds, the display will revert to the 'End USE' screen (see step 7).

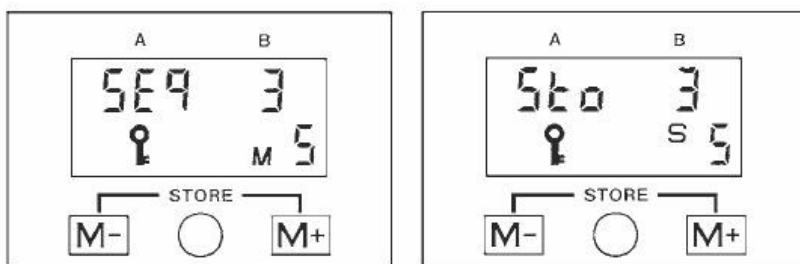

MIH user's guide

www.renishaw.com

Step 5

The sequence now has three steps:

step 1 containing memory 1

step 2 containing memory 2

step 3 containing memory 5.

To end the sequence, the end of sequence marker (E) must be placed in sequence step 4. Pressing the M+ button will increment the sequence to step 4 and the display will show the current contents as memory 4.

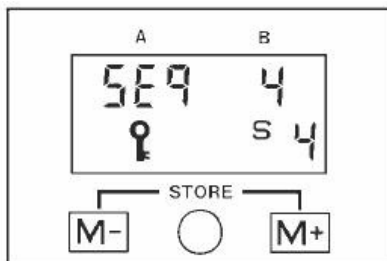

Step 6

Press M+ and M- simultaneously for between half a second and 3 seconds. This changes the display. The S character is replaced by the M character as before.

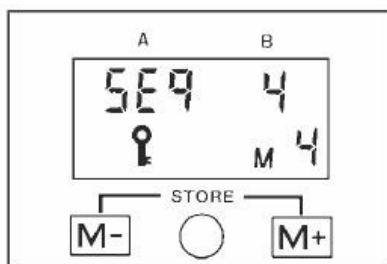

Press and hold either the M+ or M- button until the end of sequence marker (E) is displayed. This is positioned between M19 and M1.

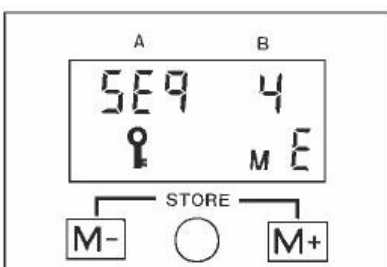

Store E in sequence step 4 by pressing the M+ and M- buttons simultaneously for between half a second and 3 seconds.

MIH user's guide

www.renishaw.com

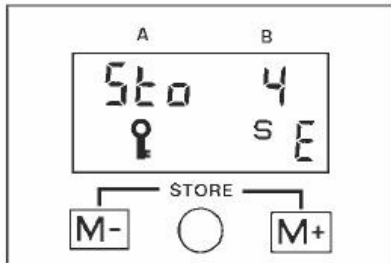

The sequence is now complete and is as follows:

Step 1 (M1), Step 2 (M2), Step 3 (M5), Step 4 (E).

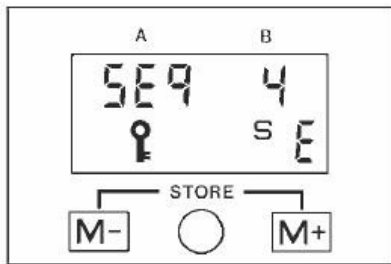

Step 7

To exit from editing a sequence, press the M+ and M- buttons simultaneously for longer than 3 seconds. The display will give a choice of either ending sequence mode or using the sequence.

Pressing the M- button or taking no action for 5 seconds will return the display to simple mode. Pressing the M+ button enables use of the stored sequence.

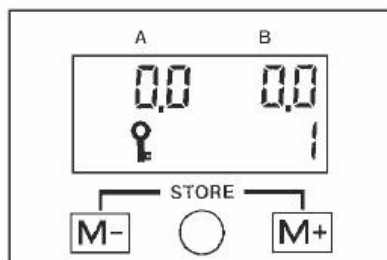
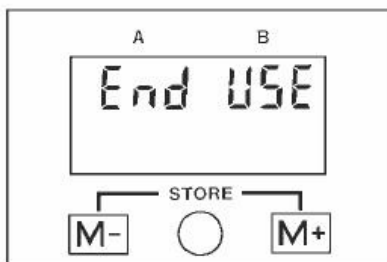

NOTE: To reset the sequence back to its original form (step 1 containing memory 1, step 2 containing memory 2, etc), simply place the end of sequence marker (E) in sequence step 1 during sequence editing.

MIH user's guide

www.renishaw.com

Using a sequence with MIH

When using a sequence, the only requirement is to position the MIH following the axis direction arrows and lock up once the correct position is reached. On unlock, the sequence will automatically increment to the next step and the direction arrows will indicate the direction each axis must be rotated to, in order to achieve the position stored in that step.

Step 1

To use a sequence, either press the M- button from the 'USE Ed' display or the M+ button from the 'End USE' display. Either of these actions will automatically start the sequence at step 1. The memory contents of sequence step 1 are displayed and the flashing direction arrows indicate the direction in which each axis must be rotated to achieve the position stored in sequence step 1. If the head is already in this position, the position confirmation block will be displayed.

If the head is not in this position, unlock the head and follow the direction arrows. The display will show live positional data and the position confirmation block will confirm when the correct position has been reached.

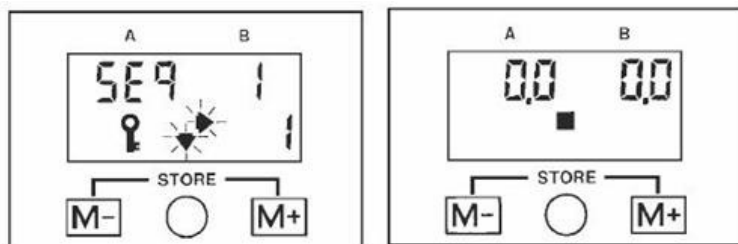

Step 2

Locking the head in this position returns the display to show the sequence step number and its contents. The corresponding probe tip number can now be selected and points taken.

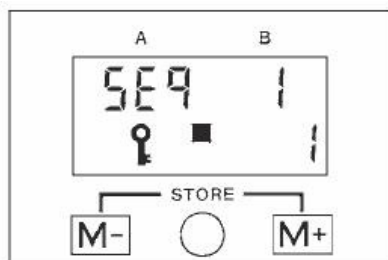

MIH user's guide

www.renishaw.com

Step 3

When the head is next unlocked, the direction arrows will show the way to achieve the position stored in sequence step 3. On locking up in the correct position, the display will show sequence step 3 and its memory contents, along with the position confirmation block.

If the head is locked in an incorrect position, flashing direction arrows will instruct the user to unlock and try again.

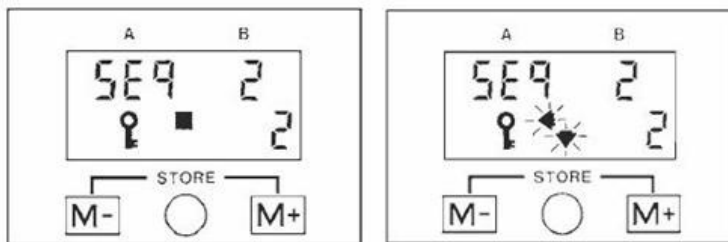

Step 4

If the head is accidentally unlocked in a sequence step position before points can be taken, simply re-lock the head and press the M+ or M- buttons to step through the sequence until the correct step is reached.

When the last step in the programmed sequence is reached, the sequence will automatically loop back to the first step. This will only occur if the end of sequence marker (E) has been correctly placed during sequence editing.

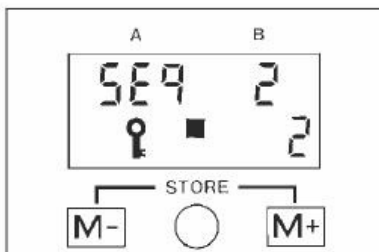

Step 5

Pressing the M+ and M- buttons simultaneously for longer than 3 seconds will give the choice to either re-use the sequence (press M+) or end using sequence mode (press M-).

Pressing M+ will take the user back to step 1 in the sequence. Pressing M- or taking no action for 5 seconds will transfer the display back to simple mode.

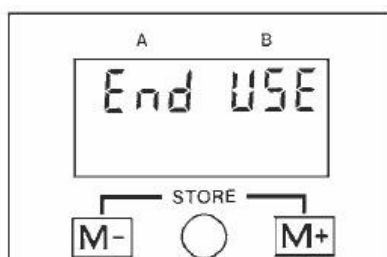

Summary of button operation

Datum mode

Button operation	Effect
[M+] or [M-]	[No change]
[M+] and [M-]	Simple mode entered

Simple mode

Button operation	Effect
[M+] or [M-]	Memory mode entered
[M+] and [M-] held for longer than 5 seconds	Sequence mode entered

Memory mode

Button operation	Effect
[M+]	Increments memory number
[M-]	Decrements memory number
[M+] held for longer than 0.5 seconds	Scrolls up memory number
[M-] held for longer than 0.5 seconds	Scrolls down memory number
[M+] and [M-] held for longer than 0.5 seconds	Stores current position
[No action] for longer than 10 seconds	Simple mode entered

Sequence mode

Select sequence mode function

Button operation	Effect
[M+]	Edit sequence mode entered
[M-]	Use sequence mode entered
[No action] for longer than 5 seconds	Simple mode entered

MIH user's guide

www.renishaw.com

Select sequence step in sequence edit

Button operation	Effect
[M+]	Increments step number
[M-]	Decrements step number
[M+] held for longer than 0.5 seconds	Scrolls up step number
[M-] held for longer than 0.5 seconds	Scrolls down step number
[M+] and [M-] held for longer than 0.5 seconds	Selects memory number routine
[No action] for longer than 3 seconds	Exits edit sequence mode

Select memory number in sequence edit

Button operation	Effect
[M+]	Increments memory number
[M-]	Decrements memory number
[M+] held for longer than 0.5 seconds	Scrolls up memory number
[M-] held for longer than 0.5 seconds	Scrolls down memory number
[M+] and [M-] held for longer than 0.5 seconds	Stores memory number in current sequence step and returns to select sequence step
[No action] for longer than 3 seconds	Exits edit sequence mode

Use sequence mode

Button operation	Effect
[M+]	Increments step number
[M-]	Decrements step number
[M+] held for longer than 0.5 seconds	Scrolls up step numbers
[M-] held for longer than 0.5 seconds	Scrolls down step numbers
[M+] and [M-] held for less than 3 seconds	[No change]
[M+] and [M-] held for longer than 3 seconds	Exits edit sequence mode

Exit sequence mode

Button operation	Effect
[M+]	Use sequence mode entered
[M-] or [No action] for longer than 5 seconds	Simple mode entered

Accessories

MAPS (manual autojoint probe stand)

The Renishaw manual autojoint probe stand (MAPS) is a low-cost storage rack for up to six autojointed probe / extension combinations. As a complementary product to the MIH, MAPS allows the user to manually insert or remove pre-datumed probe / extension set-ups for protective storage or use with the MIH. MAPS can be either wall-mounted or bolted directly to the CMM table for easy access.

For further information on MAPS see the user's guide (Renishaw part number H-1000-5300).

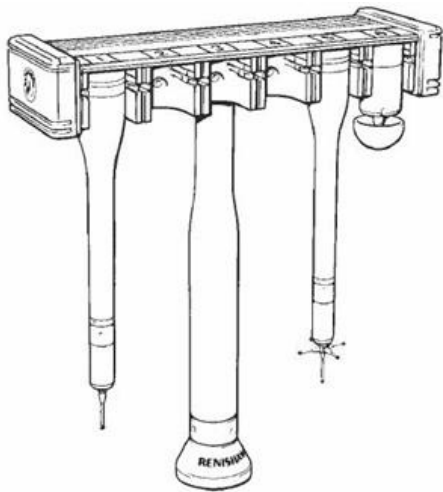

MIH user's guide

www.renishaw.com

Autojoint extensions / adaptors

A large range of autojoint probe extensions / adaptors are available from Renishaw providing easy access to the deepest of features.

Utilising the patented Renishaw autojoint, probing set-ups can be simply locked onto the MIH without the need to requalify each time, yielding maximum flexibility and valuable time saving.

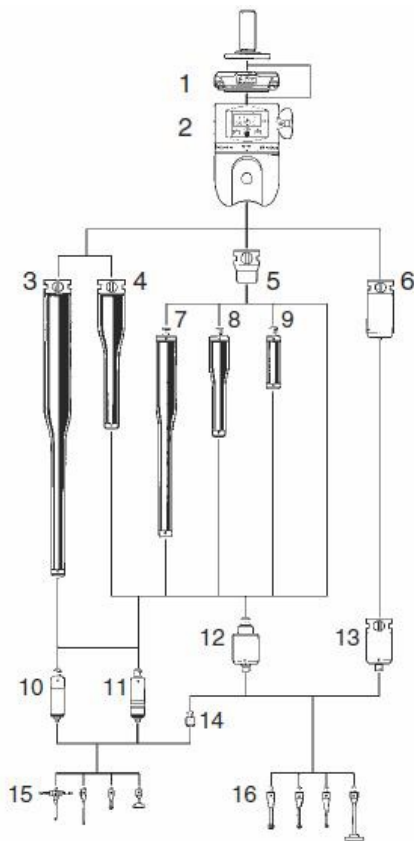

Key	Description	Key	Description
1	AM1	9	PEL1
2	MIH	10	TP2
3	PAA3	11	TP2
4	PAA2	12	TP6
5	PAA1 adaptor	13	TP6A
6	PEM1	14	M2 / 3 adaptor
7	PEL3	15	M2 thread styli
8	PEL2	16	M3 thread styli

MIH user's guide

www.renishaw.com

Shanks

Renishaw provide an extensive range of machine mounting shanks to fit most makes of CMM. Please take care when mounting the MIH with a parallel shank, as any rotational movements will invalidate any stored data.

CAUTION: Always fit mounting shanks to the MIH by using the screws supplied (M3 5 mm (0.20 in) long). The use of longer screws will cause serious internal damage to the head.



AM1 adjustment module

The AM1 (Renishaw part number A-1026-0320) is a compact adjustment module for accurately aligning the probe heads with the CMM axes and / or the Renishaw autochange rack. In addition, an in-built quick release bayonet mechanism allows the head to be removed for storage and replaced without the need to re-align. Limited overtravel protection is also provided by the AM1.



MIH user's guide

www.renishaw.com

Dimensions

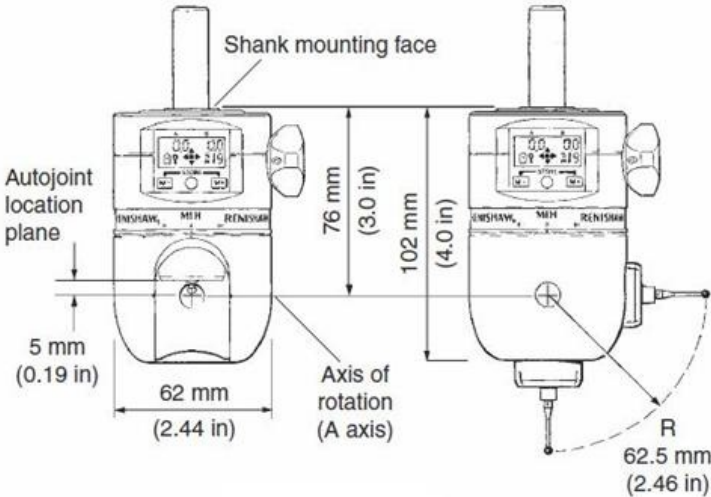

MIH user's guide

www.renishaw.com

Specification

Mechanical specification

Probe mounting	Renishaw autojoint
Autojoint repeatability (at the stylus tip) (2σ)	0.5 μm (0.00002 in) *
Probe status indicator	LED
Swept radius	62 mm (5.44 in) *
MIH positional repeatability (at the stylus tip) (2σ)	1 μm (0.00004 in) *
Accuracy of step spacing from theoretical position in each axis (at the stylus tip)	±0.3 mm (±0.012 in) *
Total angular movement A-axis	0° - 105° in 7.5° step = 15 positions
Total angular movement B-axis	±180° in 7.5° steps = 48 positions
Total number of positions	720
Support limit of head (unlocked)	150 mm (5.91 in) using PAA2 and TP6
Maximum extension length	300 mm (11.81 in) using PAA3 and TP6
Lock / unlock mechanism	Single thumbwheel rotation
Weight	580 g (1.3 lb)
Working temperature range	10 °C - 40 °C (50 °F - 105 °F)

* Using a TP6A fitted with a 21 mm (0.83 in) stylus

Electrical specification

Probe connector	Renishaw 5-pin DIN connector
Battery type to power LCD	6 V silver oxide alkali manganese (Ø12 mm (0.48 in) × 25 mm (0.98 in))
Battery type	Part number
Varta V28PX	P-BT03-0011

Alternatives:

- Duracell lithium
- Kodak lithium
- Varta lithium



CAUTION: Care must be taken when disposing of batteries. DO NOT INCINERATE.

MIH user's guide

www.renishaw.com

Battery life

Typical battery life (10 minutes / day unlock time):

Before low battery warning	40 weeks
After low battery warning	11 days

Battery life with heavy usage (20 minutes / day unlock time):

Before low battery warning	26 weeks
After low battery warning	8 days

MIH user's guide

www.renishaw.com

Troubleshooting

Poor repeatability (probe changing)

Possible causes	Checks / remedial action
Loose mounting	Ensure shank mounting screws are tight and shank is securely mounted in machine quill.
Dirty or damaged autojoint	Inspect autojoint probe connection contacts for damage and contamination. Clean with a stiff brush if necessary.
Autojoint lock-procedure incorrect	Ensure probe setup is locked onto the head correctly using the autojoint key.
Probe extension too long	Ensure maximum extension bar (300 mm) is not exceeded and the extensions longer than 150 mm are supported on lock up.

Poor repeatability (head positioning)

Possible causes	Checks / remedial action
Loose mounting	Ensure shank mounting screws are tight and shank is securely mounted in machine quill.
Head lock-up procedure incorrect with long extensions	Ensure maximum extension bar (300 mm) is not exceeded and the extensions longer than 150 mm are supported on lock up.

Incorrect LCD function

Possible causes	Checks / remedial action
Battery power low	If low battery indicator is shown, replace battery. If not, head may be faulty (see note below).

No LCD function

Possible causes	Checks / remedial action
No battery present or battery inserted incorrectly	Ensure battery is present and inserted correctly.

Unexpected software modes entered

Possible causes	Checks / remedial action
Buttons not pressed simultaneously	Ensure simultaneous operation when appropriate (e.g. to enter 'Sequence mode', if buttons are not pressed simultaneously, 'Memory mode' is entered).
Time-out exceeded	On timeout (no button presses or head movement for a period of time) the LCD will revert to 'Simple mode' if locked or to a power down state if unlocked

MIH user's guide

www.renishaw.com

No probe signal and / or no probe status LED

Possible causes	Checks / remedial action
Cabling faulty / not connected	Check continuity of cabling from head to interface machine control.
Probe / extension bars faulty	Check probe / extensions are working correctly by exchange / elimination / continuity check - if faulty return to Renishaw service centre for repair.
Probe interface faulty / not connected	Ensure correct connection of interface / machine control.

When inserting battery, self test mode is entered

Possible causes	Checks / remedial action
Button pressed during battery insertion	Re-insert battery ensuring buttons are not pressed OR press both buttons simultaneously three times to enter ' Datum mode '.

 **NOTE:** The MIH contains no user serviceable parts and should be returned to Renishaw if suspected faulty.

Checks / remedial action:

- Ensure shank mounting screws are tight and shank is securely mounted in machine machine quill
- Inspect autojoint probe connection contacts for damage and contamination. Clean with a stiff brush if necessary.
- Ensure probe set-up is locked onto probe head correctly using the autojoint key.
- Ensure maximum extension bar of 300 mm (11.81 in) is not exceeded and extensions longer than 150 mm (5.91 in) are supported on lock-up.
- If low battery indicator is shown, replace battery. If not, head may be faulty (see note above).
- Ensure battery is present and is inserted correctly (refer to 'Installation' for correct procedure).
- Ensure simultaneous operation when appropriate (e.g. to enter sequence mode, if buttons are not pressed simultaneously, memory mode is entered).
- On time-out (no button presses or head movement for a period of time) the LCD will revert to simple mode if locked, or power down if unlocked.
- Check continuity of cabling from head to interface / machine control (refer to installation section for pin connections).
- Check probe / extensions are working correctly by exchange / elimination / continuity check - if faulty return to Renishaw service centre for repair.
- Ensure correct connection of interface / machine control.
- Re-insert battery ensuring buttons are not pressed or press both buttons simultaneously three times to enter datum mode.

MIH user's guide

www.renishaw.com

Self test

i **NOTE:** These tests are for diagnostic purposes only.

The self test function can only be entered by pressing the M+ or M- button whilst the battery is being inserted. If this should happen accidentally, either refit the battery or step through the function by pressing both M+ and M- buttons three times to enter 'Datum mode'.

LCD test

This test cycles round the LCD displaying each segment in turn.

Pressing the M+ button will display all LCD segments simultaneously.

Pressing the M- button will display the MIH software version number.

Press the M+ and M- buttons simultaneously to transfer to the encoder test.

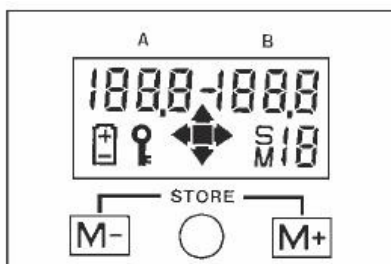

Encoder test

The head should be locked during this test.

Any positional error within the A or B-axis encoders will be detected and displayed in the self test.

Press M+ and M- simultaneously to transfer to the battery test.

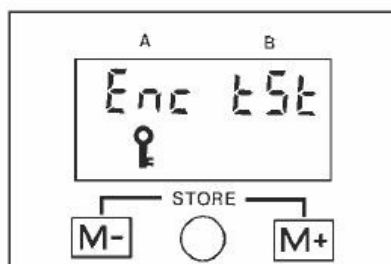

MIH user's guide

www.renishaw.com

Battery test

This function is used by Renishaw when setting the low battery indicator threshold.

To step through this function, press the M+ and M- buttons simultaneously to transfer to 'Datum mode'.

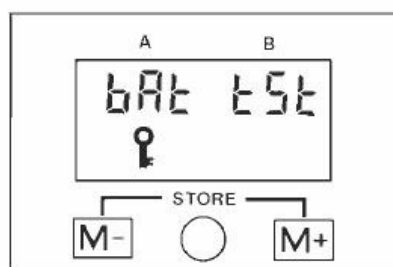

Maintenance

The MIH contains no user serviceable parts.

The MIH may be cleaned by wiping with a dry, lint-free cloth.

Renishaw plc
New Mills, Wotton-under-Edge
Gloucestershire, GL12 8JR
United Kingdom

T +44 (0)1453 524524
F +44 (0)1453 524901
www.renishaw.com/cmmsupport



**For worldwide contact details,
please visit our main website at
www.renishaw.com/contact**